

Article number: 209512M1046259ST

Description: E+G Pulling latches for clamps GN 852  
GN 951.2-M10-46-259-ST

## Measures

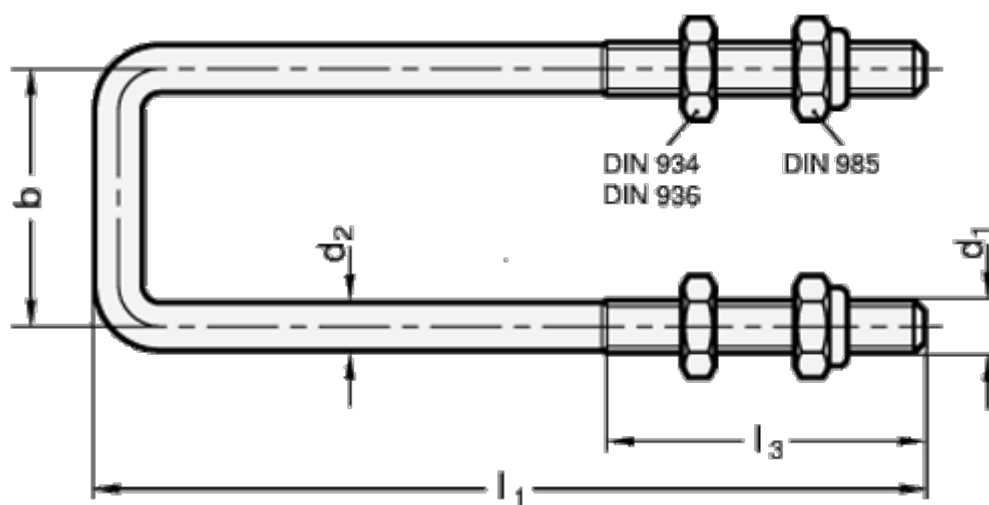

$b = 46$   
 $d_1 = M10$   
 $d_2 = 9.0$   
 $l_1 = 259$   
 $l_3 = 45.0$